





Há mais de **30 anos**  
tendo a **qualidade** como  
**compromisso**



# ÍNDICE

<b>ESTICADOR DE CORRENTE</b>	<b>04</b>
<b>TRAVA DO PINHÃO</b>	<b>05</b>
<b>SUORTE PISCA - TRASEIRO INTERNO</b>	<b>06</b>
<b>SUORTE PROTETOR - PLACA UNIVERSAL</b>	<b>06</b>
<b>SUORTE FAROL ARANHA</b>	<b>06</b>
<b>SUORTE ESCAPAMENTO</b>	<b>09</b>
<b>SUORTE PARALAMA - TRASEIRO / DIANTEIRO</b>	<b>10</b>
<b>ARO DE FAROL</b>	<b>12</b>
<b>GUIDÃO E PESO</b>	<b>13</b>
<b>PEDAL DE FREIO</b>	<b>15</b>
<b>PEDAL DE APOIO - ESTRIBO</b>	<b>16</b>
<b>CAVALETE LATERAL</b>	<b>18</b>



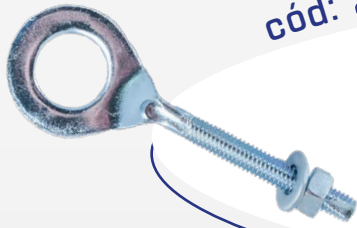

cód: **201820**

**Item: ESTICADOR DE CORRENTE**

**Aplicação: HONDA CG 125  
HONDA TODAY 125  
HONDA TITAN 125 COMPL.**

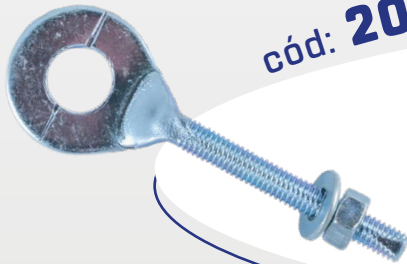

cód: **205520**

**Item: ESTICADOR DE CORRENTE**

**Aplicação: HONDA BIZ COMPL.**

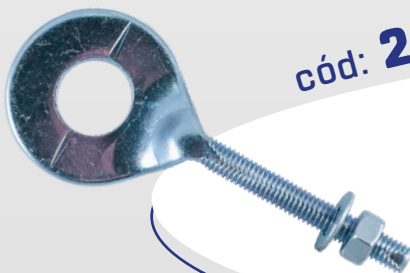

cód: **205820**

**Item: ESTICADOR DE CORRENTE**

**Aplicação: HONDA TITAN 150 COMPL.**



cód: **202010**

**Item: ESTICADOR DE CORRENTE**

**Aplicação: YAMAHA RX  
YAMAHA YBR FACTOR F.PQ.  
COMPL.**

**cód: 201910**

**Item: ESTICADOR DE CORRENTE**

**Aplicação: YAMAHA RX RD RDZ F. GR. COMPL.**



**cód: 205620**

**Item: ESTICADOR DE CORRENTE**

**Aplicação: YAMAHA CRYPTON LD DIR.  
(FURO MENOR)  
COMPL.**



**cód: 205720**

**Item: ESTICADOR DE CORRENTE**

**Aplicação: YAMAHA CRYPTON LD ESQ  
(FURO MAIOR)  
COMPL.**



**cód: 2100**

**Item: TRAVA DO PINHÃO**

**Aplicação: HONDA TITAN 125/150/160**

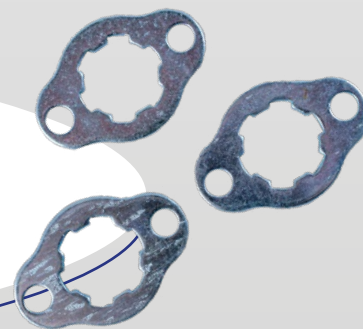

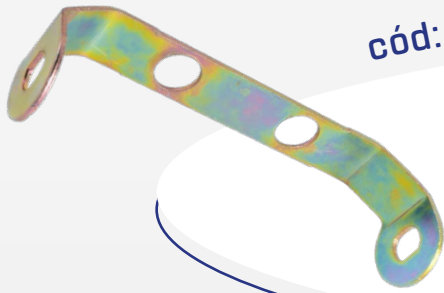

cód: **1100**

**Item: SUPORTE PISCA  
TRASEIRO INTERNO**

**Aplicação: HONDA TITAN 125 00-04  
HONDA FAN 125 05-08**

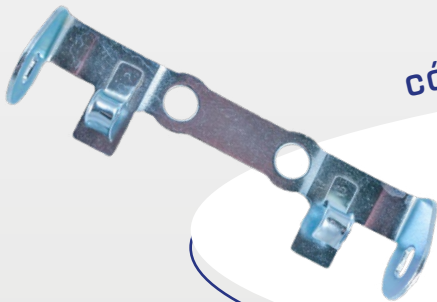

cód: **1101**

**Item: SUPORTE PISCA  
TRASEIRO INTERNO**

**Aplicação: HONDA TITAN 150 04-08**



cód: **1130**

**Item: SUPORTE PROTETOR  
PLACA UNIVERSAL**

**Aplicação: MERCOSUL 20 X 16CM  
(AÇO)**



cód: **1202**

**Item: SUPORTE FAROL ARANHA**

**Aplicação: HONDA TITAN 125  
2000-2004 PRETO**

cód: **1203**

**Item: SUPORTE FAROL ARANHA**

**Aplicação: HONDA TITAN 125  
2000-2004 CROMADO**



cód: **1204**

**Item: SUPORTE FAROL ARANHA**

**Aplicação: HONDA FAN 125  
2005-2008 PRETO**



cód: **1205**

**Item: SUPORTE FAROL ARANHA**

**Aplicação: HONDA FAN 125  
2005-2008 CROMADO**

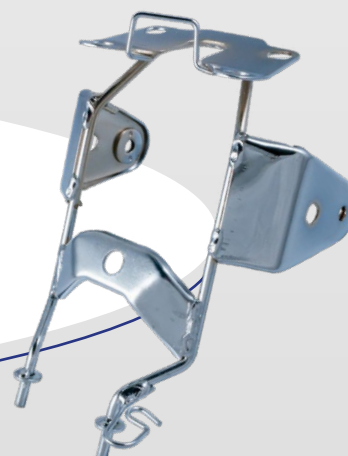

cód: **1208**

**Item: SUPORTE FAROL ARANHA**

**Aplicação: HONDA FAN 125  
2009-2013 PRETO**





cód: **1209**

**Item: SUPORTE FAROL ARANHA**

**Aplicação: HONDA FAN 125  
2009-2013 CROMADO**



cód: **1200**

**Item: SUPORTE FAROL ARANHA**

**Aplicação: HONDA TITAN 150  
2004-2008 PRETO**

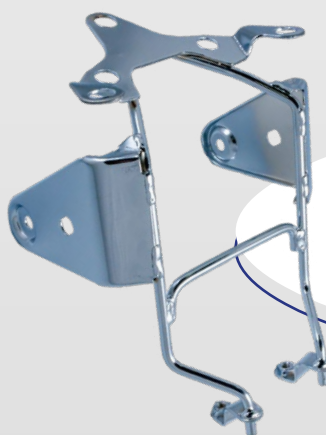

cód: **1201**

**Item: SUPORTE FAROL ARANHA**

**Aplicação: HONDA TITAN 150  
2004-2008 CROMADO**



cód: **1210**

**Item: SUPORTE FAROL ARANHA**

**Aplicação: HONDA FAN 150  
2009-2013 PRETO**



cód: **1211**

**Item: SUPORTE FAROL ARANHA**

**Aplicação: HONDA FAN 150  
2009-2013 CROMADO**

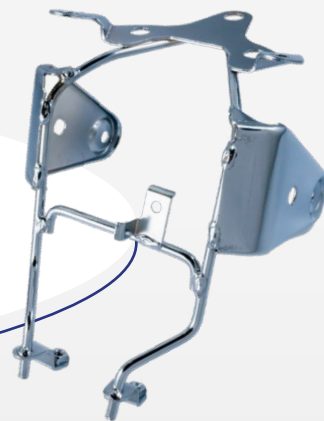

cód: **1206**

**Item: SUPORTE FAROL ARANHA**

**Aplicação: YAMAHA YBR 125  
2000-2008 PRETO**



cód: **1207**

**Item: SUPORTE FAROL ARANHA**

**Aplicação: YAMAHA YBR 125  
2000-2008 CROMADO**

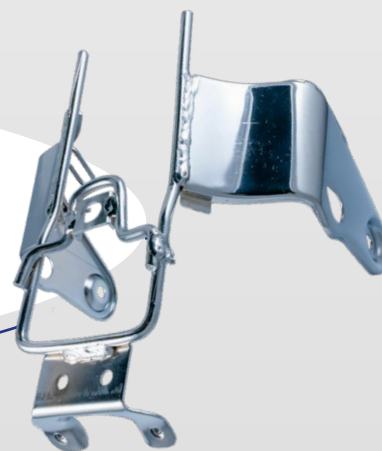

cód: **1320**

**Item: SUPORTE ESCAPAMENTO**

**Aplicação: HONDA TITAN 150  
2004-2008 PRETO**



cód: **1321**



**Item: SUPORTE ESCAPAMENTO**

**Aplicação: HONDA TITAN 125 2000-2004  
HONDA FAN 125 2005-2008 PR.**

cód: **1300**

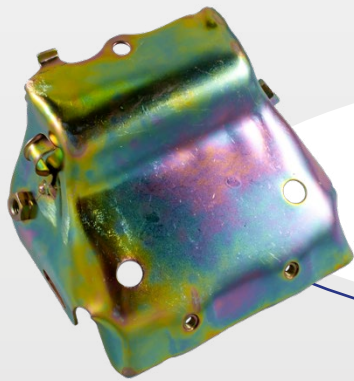

**Item: SUPORTE PARALAMA  
TRASEIRO**

**Aplicação: HONDA TODAY 1999  
HONDA TITAN 1999**

cód: **1350**

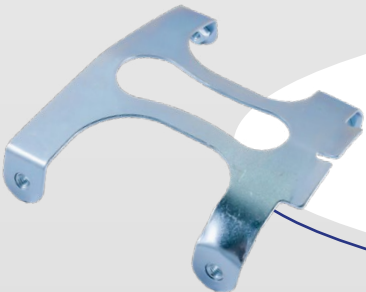

**Item: SUPORTE PARALAMA  
DIANTEIRO**

**Aplicação: HONDA TITAN 160**

cód: **1351**

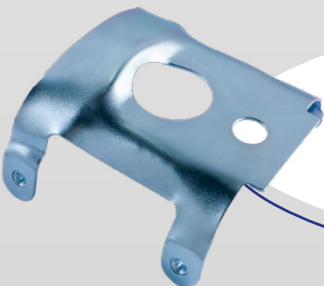

**Item: SUPORTE PARALAMA  
DIANTEIRO**

**Aplicação: HONDA TITAN/FAN 150 MIX  
2009-2013**

cód: **1352**

**Item: SUPORTE PARALAMA  
DIANTEIRO**

**Aplicação: HONDA TITAN 150 2004-2008**

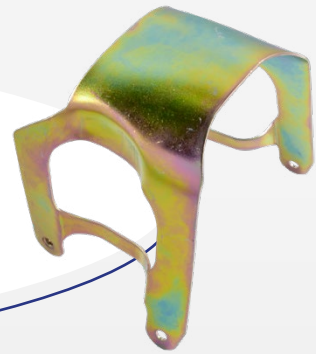

cód: **1355**

**Item: SUPORTE PARALAMA  
DIANTEIRO**

**Aplicação: HONDA CBX-TWISTER  
2001-2008 LD**



cód: **1356**

**Item: SUPORTE PARALAMA  
DIANTEIRO**

**Aplicação: HONDA CBX-TWISTER  
2001-2008 LE**



cód: **1353**

**Item: SUPORTE PARALAMA  
DIANTEIRO**

**Aplicação: YAMAHA 125 2000-2008**

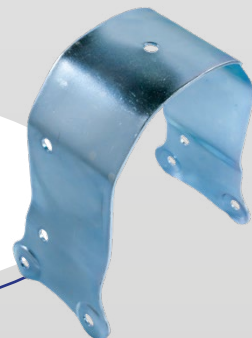

cód: **1354**



**Item: SUPORTE PARALAMA  
DIANTEIRO**

**Aplicação: YAMAHA 125 2009-2013**

cód: **1400**



**Item: ARO DE FAROL**

**Aplicação: HONDA TITAN 2000  
HONDA TITAN 150 PR.**

cód: **1401**



**Item: ARO DE FAROL**

**Aplicação: HONDA TITAN 2000  
HONDA TITAN 150 CR.**

cód: **1402**



**Item: ARO DE FAROL**

**Aplicação: HONDA CBX 250  
HONDA TWISTER PR.**

**cód: 1403**

**Item: ARO DE FAROL**

**Aplicação: CBX 250 TWISTER CR.**



**cód: 1404**

**Item: ARO DE FAROL**

**Aplicação: YAMAHA FACTOR 2008-2013  
FAZER 2005/2009 PR.**



**cód: 1405**

**Item: ARO DE FAROL**

**Aplicação: YAMAHA FACTOR 2008-2013  
FAZER 2005/2009 CR.**



**cód: 3500**

**Item: PESO DE GUIDÃO**

**Aplicação: COMPATÍVEL C/ PCX  
C/ PARAFUSO**

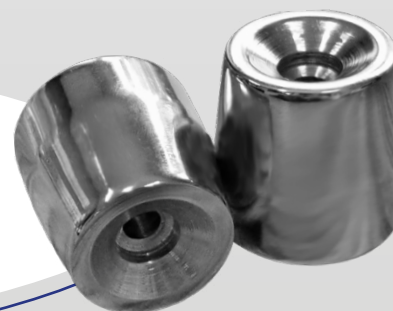

cód: **3001**

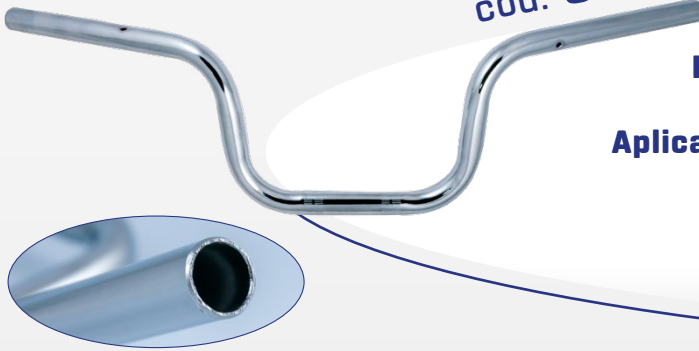

Item: **GUIDÃO**

Aplicação: **HONDA TITAN 160  
MODELO ORIGINAL  
S/ CONTRAPESO (OCO) CR.**

cód: **3002**

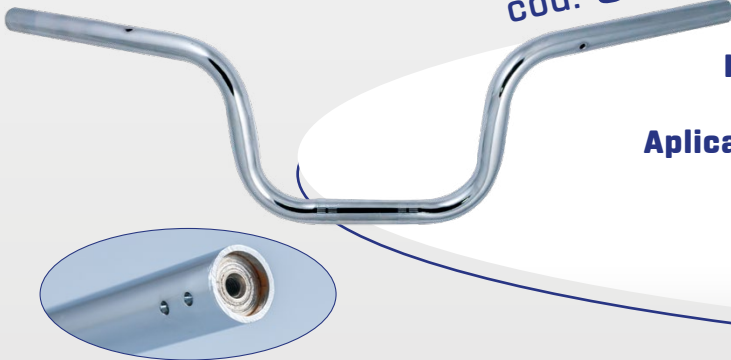

Item: **GUIDÃO**

Aplicação: **HONDA TITAN 160  
MODELO ORIGINAL  
C/ CONTRAPESO CR.**

cód: **3003**

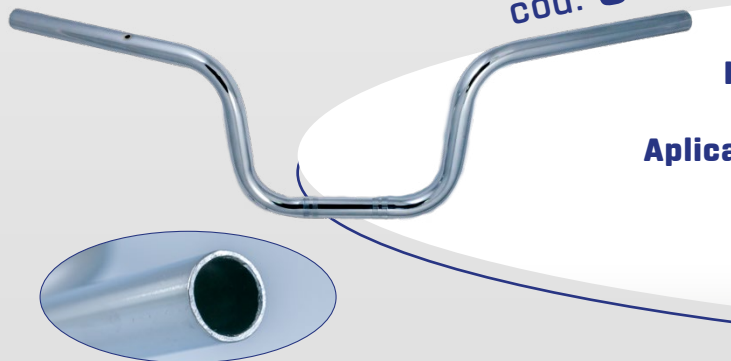

Item: **GUIDÃO**

Aplicação: **HONDA TITAN 150 2004-2008  
MODELO ORIGINAL  
S/ CONTRAPESO CR.**

cód: **3004**

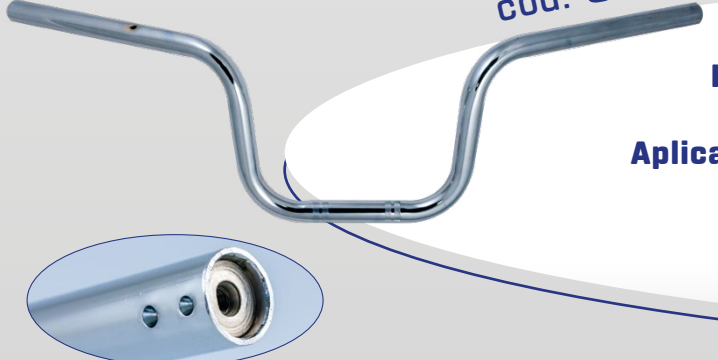

Item: **GUIDÃO**

Aplicação: **HONDA TITAN 150 2004-2008  
MODELO ORIGINAL  
C/ CONTRAPESO CR.**

cód: **3005**

**Item: GUIDÃO**

**Aplicação: HONDA CB300  
MODELO ORIGINAL  
S/ CONTRAPESO CR.**

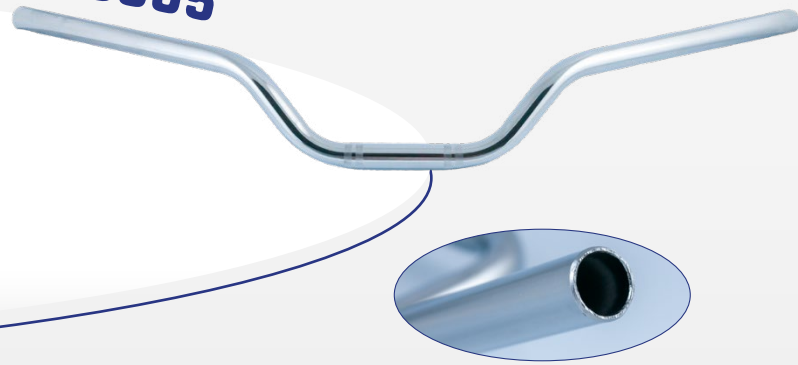

cód: **3006**

**Item: GUIDÃO**

**Aplicação: HONDA CB300  
MODELO ORIGINAL  
C/ CONTRAPESO CR.**

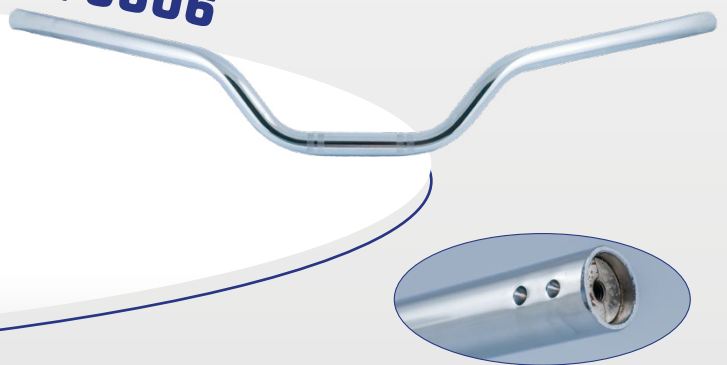

cód: **4001**

**Item: PEDAL DE FREIO**

**Aplicação: HONDA BIZ 100**

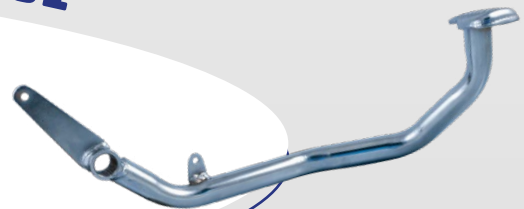

cód: **4002**

**Item: PEDAL DE FREIO**

**Aplicação: HONDA TITAN 2000**

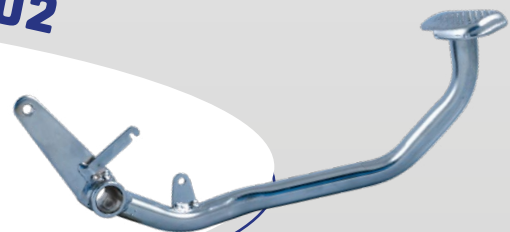



cód: **4003**

**Item: PEDAL DE FREIO**

**Aplicação: HONDA TODAY ATÉ 1999  
HONDA TITAN ATÉ 1999**



cód: **4004**

**Item: PEDAL DE FREIO**

**Aplicação: HONDA TITAN 150**



cód: **4007**

**Item: PEDAL DE FREIO**

**Aplicação: HONDA BIZ 125**

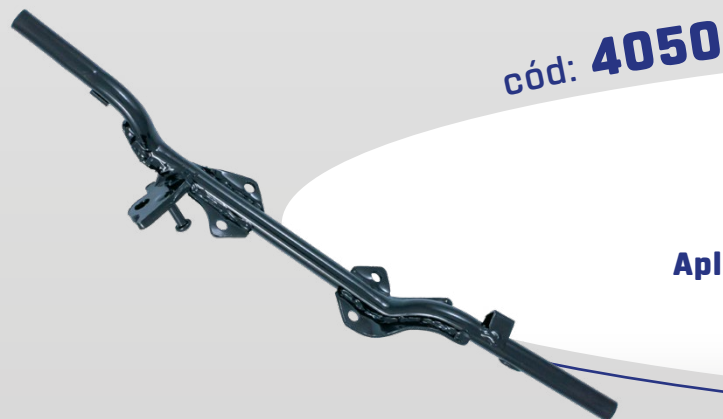

cód: **4050**

**Item: PEDAL DE APOIO  
ESTRIBO**

**Aplicação: HONDA TITAN /1999**



cód: **4051**

**Item: PEDAL DE APOIO  
ESTRIBO**

**Aplicação: HONDA TITAN 150 /2008**

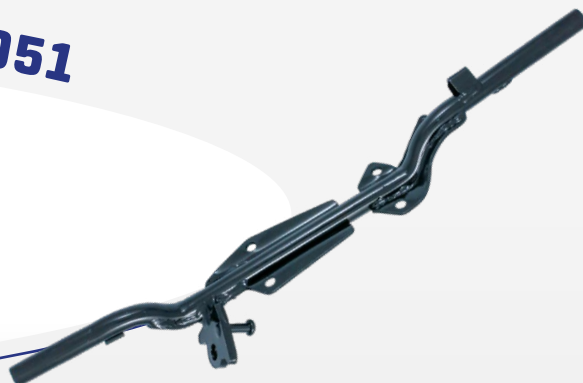

cód: **4052**

**Item: PEDAL DE APOIO  
ESTRIBO**

**Aplicação: HONDA TITAN 150 2009/...  
HONDA FAN 150 2009/...**



cód: **4053**

**Item: PEDAL DE APOIO  
ESTRIBO**

**Aplicação: HONDA FAN MIX 150 2014/...  
HONDA TITAN 160 2014/...**



cód: **4054**

**Item: PEDAL DE APOIO  
ESTRIBO**

**Aplicação: HONDA FAN MIX 150  
TITAN 160 CR.**

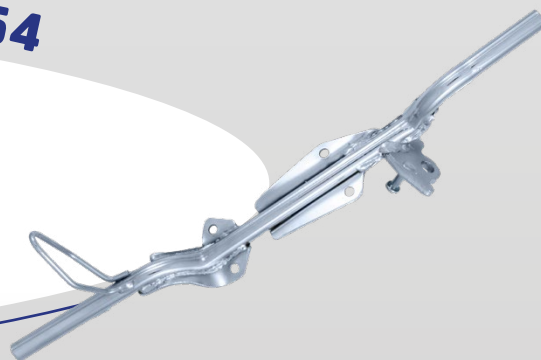

cód: **4100**



**Item: CAVALETE LATERAL**

**Aplicação: HONDA CG 150  
HONDA TITAN FAN 150  
C/ BORRACHA PR.**

cód: **4101**



**Item: CAVALETE LATERAL**

**Aplicação: HONDA TITAN 2000  
C/ BORRACHA PR.**

cód: **4102**



**Item: CAVALETE LATERAL**

**Aplicação: HONDA CG TITAN 125 150 160  
C/ BORRACHA PR.**

cód: **4103**



**Item: CAVALETE LATERAL**

**Aplicação: HONDA CG TITAN 125 150 160  
C/ BORRACHA CR.**

cód: **4150**

**Item: CAVALETE LATERAL  
C/ REGULAGEM**

**Aplicação: HONDA CG FAN TITAN  
125 150 160 PR.**



cód: **4151**

**Item: CAVALETE LATERAL**

**Aplicação: HONDA CG FAN TITAN  
125 150 160 CR.  
C/ REGULAGEM**

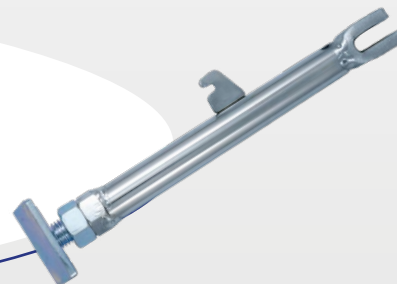

cód: **4152**

**Item: CAVALETE LATERAL**

**Aplicação: HONDA BROS  
125 150 160 PR  
C/ REGULAGEM**

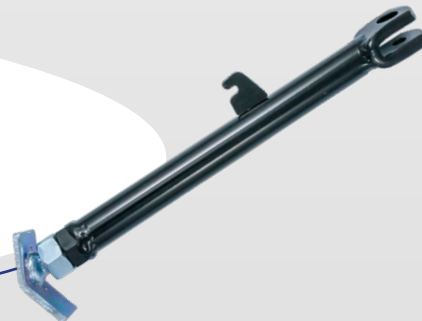

cód: **4153**

**Item: CAVALETE LATERAL**

**Aplicação: HONDA BROS  
125 150 160 CR.  
C/ REGULAGEM**

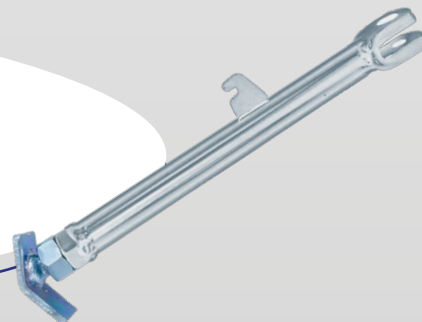



R. Brasília De Minas, 338, Parque Alvorada,  
07242-380, Guarulhos-SP

**Fone: (11) 2484-9758**  
**Whatsapp: (11) 98559-7762**  
**E-mail: [haustind@uol.com.br](mailto:haustind@uol.com.br)**